

SECTIONAL DOOR

# STEEL DOOR INSULATED

## Key Features

- Pre-Painted Galvanized Steel Curtain
- Foamed-In-Place Insulated Sections
- Insulated Custom Window Options
- Impact-Adjustable Bottom Sections
- Manual Chain Hoist or Automatic Operator

## Major Benefits

- **Advanced Performance:**  
High R-Value and eco-friendly insulation properties prevent heat and cold air transfers, delivering consistent energy savings.
- **Reliable Efficiency:**  
Solid steel construction and heavy-duty hardware deliver smooth operation, low maintenance, and a long lifecycle.
- **Proven Security:**  
Customizable vision panels provide natural light penetration while allowing an unobstructed view of traffic conditions.

# STEEL DOOR INSULATED

## General Specifications

Steel Embossment	Stucco
Door Thickness	1-3/8" / 1"(2.5cm) / 2" (5.1cm) / 3"(7.6cm)
Insulation	Polystyrene
Max / Min. Width	20'2", 24'2", 40'2" / 5', 6'
Max / Min. Weight	16'1", 26'1" / 7'
Paint finish Warranty	10 years

## Track Lift Options

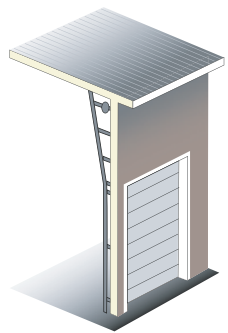

Vertical Lift

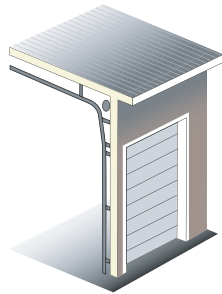

Horizontal Lift

## Construction

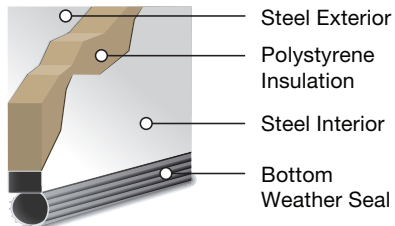

Model 2432

- Steel Exterior
- Polystyrene Insulation
- Steel Interior
- Bottom Weather Seal

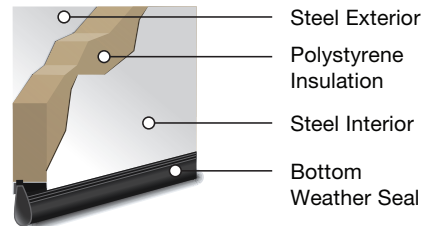

Model 2732

- Steel Exterior
- Polystyrene Insulation
- Steel Interior
- Bottom Weather Seal

## Panel Design

Flush Panel

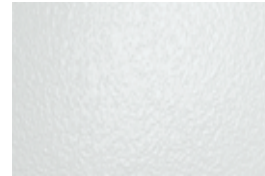

Pencil Grooved

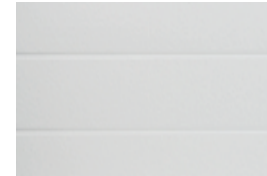

Wide Groove

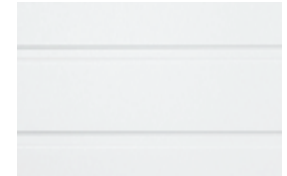

## Window Options

26"x13"



Double Insulated Acrylic Windows With Black Frame\*

24"x12"



Tempered Insulated Glass With Black Or White Frame\*

24"x8"



Tempered Insulated With Black Frame\*

24"x6"



Double Insulated Acrylic Windows With Black Frame\*

\*Ask dealer for more details

## Colors

True White



Sandtone



Gray



Brown



More than 700 color choices\*



\*Ask dealer about custom color options. Price upcharge may apply.

SECTIONAL DOOR

# ALUMINUM MULTI-VIEW DOOR

## Key Features

- Extruded Aluminum Rails and Stiles
- High-Visibility Equal Glass Height Sections
- Protective Bulb Seal and Bottom Weather Seal
- Custom Glazing and Insulated Panel Options
- Manual Chain Hoist or Automatic Operator

## Major Benefits

- **Proven Safety:**  
Full-view vision panels provide natural light penetration while allowing an unobstructed view of traffic conditions.
- **Reliable Strength:**  
2-inch thick extruded commercial-grade aluminum frame ensures durability, low maintenance, and corrosion-resistance.
- **Custom Functionality:**  
Special configurations provide a modern style for automotive stations, parking garages, sports complexes, and more.

## Technical Specifications

Material	Aluminum
Construction Layers	Single
Door Thickness	2" (5.1cm)
Section Heights	Varies by door height
Max. / Min. Door Width	20' 2" (in 1" increments) / 2' 0"
Max. / Min. Door Height	20' 1" / 6' 0"
Clearview Strut System	Only required for doors ≥ 16'
Finish Warranty	5 Years / 3 Years
Glass Warranty	1 Year
Glazing Options	Clear / Obscure / Green / Bronze / Gray / Greylite / Frost / Snow / Whiteout / Black Ice

## Door Design

Up to 8'2" Wide – 1 Panel

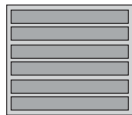

Up to 10'2" Wide – 2 Panels



8'3"-16'2" Wide – 2 Panels

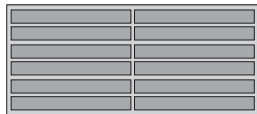

10'3"-16'2" Wide – 3 Panels

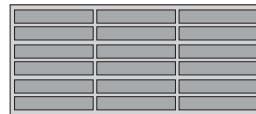

16'3" - 20'2" Wide – 3 Panels



16'3"-20'2" Wide – 4 Panels

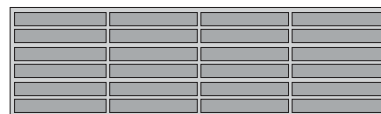

## Door Construction

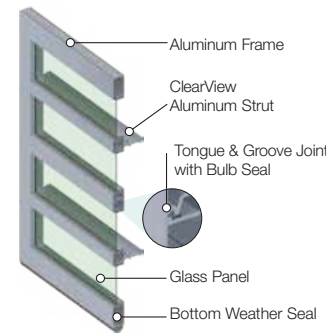

Single-layer (Aluminum)

- 2" thick extruded aluminum rails & stiles.
- Tongue and groove section joint with leading-edge bulb seal and bottom weather seal provide greater protection from the elements.
- Equal glass heights in all sections of a door.
- Glass expands up to 8'2" wide.

## Colors

### Standard

#### Anodize



Clear (An)



Dark Bronze (Ad)



Black (Ba)

#### Paint



Powder Coat (Wh)

### Special Order

#### Anodize



Champagne



Copper



Bronze

#### Paint



White

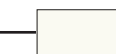

Bone White



Ivory



Sandstone



Burnt Sun



Sierra Tan



Beige



Light Seawolf Beige



Dove Gray



Slate Gray



Charcoal Gray



Patina Green



Dark Ivy



Hartford Green



Military Blue



Interstate Blue



Colonial Red



Boysenberry



Sage Brown



Quaker Bronze



Super Black



Carnival Red II



Classic Copper



Champagne Pearl



Pewter



Silver